

Volvo Construction Equipment
Building Tomorrow



EC950E

Volvo Excavators 90.0-91.8 t 611 hp



WELCOME TO OUR WORLD

Welcome to a world of industry leading machinery. A world where imagination, hard work and technological innovation will lead the way towards developing a future which is cleaner, smarter, and more connected. A world supported by the enduring values of the Volvo Group. A world of stability, sustainability and innovation. A world which we put our customers at the heart of.

Welcome to the world of Volvo Construction Equipment – we think you're going to like it here.

Working harder, working smarter

For over 180 years Volvo has been a pioneer in the design and manufacture of machines which set the standard for efficiency, performance and uptime. Across our range of excavators, wheel loaders and haulers, our reputation for engineering excellence is unrivalled, which means whatever your operation or application, we can provide a total fleet solution to help you succeed.

Building on our proud history, the Volvo Concept Lab continues to create cutting-edge ideas and innovative concepts, to ensure we offer customers machines which work harder and smarter long into the future.



Solutions for you

Our industry leading machines are just the start of your relationship with Volvo. As your partner, we have developed an extensive range of additional solutions to help you improve uptime, boost productivity and reduce costs.

Designed for your business

Structured across nine blocks, our portfolio of products and services are designed to complement your machine's performance and boost your profitability. Simply put, we offer some of the best guarantees, warranties and technological solutions in the industry today.

There when you need us

Whether you're buying new or used, our global network of dealers and technicians offer around-the-clock support, including machine monitoring and world-class parts availability. It's the basis of everything offered by Volvo Services, so you can be confident we've got you covered right from the start.

BUILDING TOMORROW

Big, powerful and productive

Do the bigger jobs better, stronger and faster with the EC950E. The 90 tonne crawler excavator offers the perfect combination of power and stability to handle a higher capacity in the toughest applications.

Solid stability

Operators can work with comfort and confidence in the most challenging environments with outstanding stability in the EC950E. The well-balanced and solid machine features a wide track gauge, long track length, a retractable undercarriage, and an optimized counterweight.



Powered by Volvo

Rely on a superior performance from the EC950E. Featuring a powerful 450kW Volvo D16 engine, the machine utilizes advanced technology built on decades of experience to ensure a highly productive operation.



Maximize operator productivity

For operator convenience and ease of use, all machine interfaces – including the joysticks, keypad and LCD monitor – are ergonomically positioned and designed for optimum control and efficiency. Maximizing operator productivity, the cab features a comfortable, spacious, and low-noise environment.



Durable Volvo buckets

Maximize productivity with Volvo's durable, high quality buckets. Volvo's buckets are the perfectly matched to your machine for digging in all working conditions. Choose from durable General Purpose, Heavy-duty or Extreme-Duty buckets for working in the toughest applications and most demanding environments.





BIGGER MACHINE, BIGGER RESULTS



Gain more profitability and productivity in the EC950E, Volvo's largest crawler excavator. The 90 tonne excavator delivers a high bucket capacity for more tons per hour, achieving a fast and efficient on-site production.



SUPERIOR DIGGING FORCE



In even the toughest applications, the EC950E is up to the challenge. Experience superior digging force, particularly when working with hard and heavy materials thanks to constant high hydraulic pressure delivering power to the machine when you need it.

Peak performance

Job done. With the big and powerful EC950E, no task is too tough. Increase profitability with superior digging force, quick cycle times and outstanding fuel efficiency for a maximum return on investment.

Do more in less time

Quick cycle times are achieved with the enhanced hydraulics system which increases pump power for a fast and smooth operation. Cut cycle times to a minimum with the newly developed fully electro-hydraulic system in combination with the high power and massive torque from the Volvo D16 engine.



Complete control

For a more productive and efficient operation, the new electro-hydraulic system puts superior control in the operator's hands. Utilizing intelligent technology, the system controls on-demand flow and reduces internal losses in the hydraulic circuit.



Outstanding fuel efficiency

Achieve outstanding fuel efficiency with Volvo's unique ECO Mode and electro-hydraulic system. ECO Mode optimizes the hydraulic system to reduce loss of flow and pressure. For a more efficient operation, the integrated work mode allows operators to choose the best work mode for the task at hand – select from I (Idle), F (Fine), G (General), H (Heavy) and P (Power max).



Versatility for the toughest demands

Take on the most demanding working environments with the tough and hard-working EC950E. For increased versatility the attachment management system ensures the use of various attachments, allowing the operator to pre-set hydraulic flow and pressure inside the cab through the monitor.



Always-on

Rely on maximum uptime with the big and durable EC950E – always available and ready to work. The machine's heavy-duty design, reliable and wear-resistant components, and easy service access ensure you will get the job done quickly and without delay.

Durable by design

Achieve non-stop production with the durable and reliable EC950E. Built with protected components, including a heavy-duty boom and arm, strong frame structure, the machine can be relied on for longevity and sustained uptime in demanding applications. A built-in, heavy-duty plate is featured for additional protection to the underside of the machine.



Robust protection

For added safety and durability, optional FOG (Falling Object Guard) and FOPS (Falling Object Protective Structure) certified cabs provide peace-of-mind for working in tough applications. The EC950E can also be fitted with a full length track guard for added protection.



Proven reliability

Count on a solid, reliable EC950E with Volvo's high-quality components, designed to work in perfect harmony with the machine. Volvo's commitment to rigorous testing in its development process ensures the production of well-engineered components, purpose-built for the job, and proven to be reliable in the toughest applications.



Wear-resistant digging

For a long life and superior digging, Volvo's heavy-duty bucket is built with wear-resistant, steel plates. It's perfect for quarrying and mining applications and is made out of high quality durable materials. A wide range of wear parts are offered to protect your complete bucket, such as teeth, adapter, segments, side cutter and shroud.



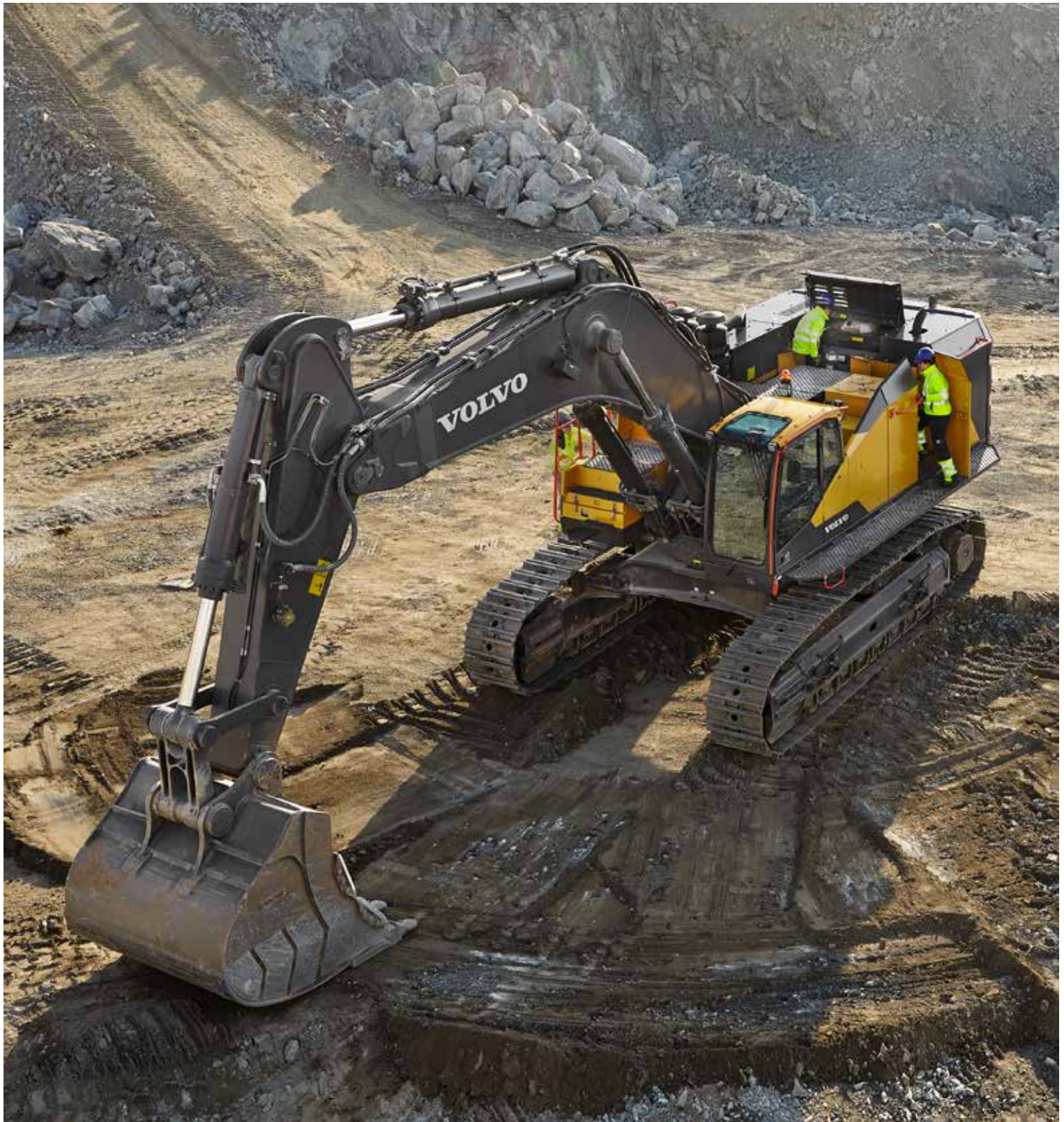

EASY SERVICE ACCESS



Maximize uptime with quick and safer servicing. Essential maintenance points are easily accessed via the wide-opening and conveniently located compartment doors using central and surrounding walkways.



MACHINE MONITORING MADE EASY



Maximize uptime through important service reminders with CareTrack. The GPS monitoring program works with the machine's diagnostic system to allow you to remotely track usage, productivity, fuel consumption and more. The system also monitors geographic machine location and can even prevent unauthorized use.

Keeping costs down

We're committed to providing a complete solution to guarantee the highest performance from your Volvo machine, including state-of-the-art support through our customer solutions. Take advantage of our unique, local dealer support network to ensure your machine achieves maximum uptime, and generates maximum profit and growth for your business.

Volvo dealer network

Volvo has the right solution for you. By listening to your requirements, we can reduce your total cost of ownership and increase your revenue. With our extensive infrastructure of technicians, workshops and dealers, Volvo has a comprehensive network to fully support you using local knowledge and global experience.



Machine diagnosis

Analyze machine usage, reduce maintenance costs and increase service life with Volvo's diagnostic analysis software. MATRIS analyses the machine's operational data and functions, which can be adjusted accordingly.



Customer Support Agreements

The range of Customer Support Agreements offer preventive maintenance, total repairs and a number of uptime services. Volvo uses the latest technology to monitor machine operation and status, giving you advice to increase your profitability. By having a Customer Support Agreement you are in control of your service costs.



Genuine Volvo Parts

Every part is vital for optimized uptime and performance of your machine. Genuine Volvo Parts are extensively tested and approved to ensure the highest quality. Talk to your local Volvo dealer to discover parts availability and quick and easy delivery via our global parts distribution network.



Up to the challenge

BIGGER MACHINE, BIGGER RESULTS



Gain more tons per hour in Volvo's largest crawler excavator, delivering a fast and efficient on-site production.

Robust protection

Optional FOG and FOPS certified cabs provide peace-of-mind for working in tough applications.

Do more in less time

Cut cycle times to a minimum with the newly developed fully electro-hydraulic system.

Complete control

The electro-hydraulic system controls on-demand flow and reduces internal losses in the hydraulic circuit.



SUPERIOR DIGGING FORCE



The EC950E features superior digging force, particularly when working with hard and heavy materials.

Durable Volvo buckets

Maximize productivity with Volvo's durable, high quality buckets, perfectly matched to your machine.

MACHINE MONITORING MADE EASY



Maximize uptime with the GPS monitoring program works with the machine's diagnostic system to allow you to remotely track usage, productivity, fuel consumption and more.

EASY SERVICE ACCESS



Maintenance points are easily accessed via the wide-opening compartment doors using central and surrounding walkways.

Powered by Volvo

Rely on a superior performance from the EC950E, featuring a powerful 450kW Volvo D16 engine.

Outstanding fuel efficiency

Achieve outstanding fuel efficiency with Volvo's unique ECO Mode and electro-hydraulic system.

Durable by design

Built with protected components, the EC950E can be relied on for longevity and sustained uptime.

Proven reliability

Count on Volvo's high-quality components, designed to work in perfect harmony with your machine.



Volvo EC950E in detail

Engine

The Volvo diesel engine delivers lower emissions, superior performance and fuel efficiency. The engine uses precise, high pressure fuel injectors, turbo charger and intercooler, and electronic engine controls to optimize machine performance.

Air Filter: 3-stage with precleaner.

Automatic Idling System: Reduces engine speed to idle when the levers and pedals are not activated resulting in less fuel consumption and low cab noise levels.

Engine	Volvo	D16E
Max power at	r/min	1 800
Net, ISO 9249/SAE J1349	kW	446
	hp	606
Gross, ISO 14396/SAE J1995	kW	450
	hp	611
Max torque	Nm	2 650
at engine speed	r/min	1 350
No. of cylinders		6
Displacement	l	16.1
Bore	mm	144
Stroke	mm	165

Electrical System

High-capacity electrical system that is well protected. Waterproof double-lock harness plugs are used to secure corrosion-free connections. The main relays and solenoid valves are shielded to prevent damage. The master switch is standard. Contronics provides advanced monitoring of machine functions and important diagnostic information.

Voltage	V	24
Batteries	V	2 x 12
Battery capacity	Ah	210
Alternator	V/A	28/80

Undercarriage

The undercarriage has a robust X-shaped frame. Greased and sealed track chains are standard.

Track shoes		51 x 2
Link pitch	mm	260.4
Shoe width, double grouser	mm	650/750/900
Bottom rollers		9 x 2
Top rollers		3 x 2

Swing System

The swing system uses an axial piston motors, driving a planetary gearbox for maximum torque. An automatic holding brake and anti-rebound valve are standard.

Max. slew speed	r/min	6.9
Max. slew torque	kNm	343

Travel System

Each track is powered by an automatic two-speed shift travel motor. The track brakes are multi-disc, spring-applied and hydraulic released. The travel motor, brake and planetary gears are well protected within the track frame.

Max. drawbar pull	kN	565
Max. travel speed (low)	km/h	2.8
Max. travel speed (high)	km/h	4.4
Gradeability	°	33

Service Refill

Fuel tank	l	1 265
Hydraulic system, total	l	900
Hydraulic tank	l	460
Engine oil	l	55
Engine coolant	l	72
Slew reduction unit	l	2 x 6.5
Travel reduction unit	l	2 x 25
PTO gear box	l	1 x 7.5

Hydraulic System

The new electro-hydraulic system and new MCV (main control valve) use intelligent technology to control on-demand flow for high-productivity, high-digging capacity and excellent fuel economy. The summation system, boom, arm and swing priority along with boom, arm and bucket regeneration provides optimum performance.

The following important functions are included in the system:

Summation system: Combines the flow of both hydraulic pumps to ensure quick cycle times and high productivity.

Boom priority: Gives priority to the boom operation for faster raising when loading or performing deep excavations.

Arm priority: Gives priority to the arm operation for faster cycle times in leveling and for increased bucket filling when digging.

Swing priority: Gives priority to swing functions for faster simultaneous operations.

Regeneration system: Prevents cavitation and provides flow to other movements during simultaneous operations for maximum productivity.

Holding valves: Boom and arm holding valves prevent the digging equipment from creeping.

Main pump. Type 3 x variable displacement axial piston pumps

Maximum flow	l/min	2 x 515; 1 x 147
--------------	-------	---------------------

Pilot pump. Type Gear pump

Maximum flow	l/min	1 x 42
--------------	-------	--------

Relief value setting pressure

Implement	MPa	34.3
Travel circuit	MPa	34.3
Slew circuit	MPa	28.4
Pilot circuit	MPa	3.9

Hydraulic Cylinders

Mono boom		2
Bore x Stroke	ø x mm	215 x 1 930
Arm		1
Bore x Stroke	ø x mm	240 x 2 180
Bucket		1
Bore x Stroke	ø x mm	200 x 1 500
ME Bucket		1
Bore x Stroke	ø x mm	230 x 1 500

Hydraulic Motors

Travel: Variable displacement axial piston motor with mechanical brake
Slew: Fixed displacement axial piston motor with mechanical brake

Cab

The operator's cab has easy access via a wide door opening. The cab is supported on hydraulic dampening mounts to reduce shock and vibration levels. These along with sound absorbing lining provide low noise levels. The cab has excellent all-round visibility. The front windshield can easily slide up into the ceiling, and the lower front glass can be removed and stored in the side door.

Integrated air-conditioning and heating system: The pressurized and filtered cab air is supplied by an automatically-controlled fan. The air is distributed throughout the cab from 14 vents.

Ergonomic operator's seat: The adjustable seat and joystick console move independently to accommodate the operator. The seat has 12 different adjustments plus a seat belt for the operator's comfort and safety.

Sound Level

Sound level in cab according to ISO 6396		
L _{pA}	dB	74
External sound level according to ISO 6395 and EU Noise Directive (2000/14/EC) and 474-1:2006 +A1:2009		
L _{WA}	dB	111

Specifications

GROUND PRESSURE

Description		EC950E					
		Boom 7.25 m, Arm 2.95m, Bucket 4 515kg(4.7m ³)			Boom 8.4 m, Arm 3.7m, Bucket 4 190kg(3.9m ³)		
		Counterweight 16 100kg			Counterweight 16 100kg		
Shoe width	Operating weight	Ground pressure	Overall width	Operating weight	Ground pressure	Overall width	
mm	kg	kPa	mm	kg	kPa	mm	
Double grouser	650	90 010	122.0	4 298	90 020	122.0	4 298
	750	90 710	106.6	4 300	90 720	106.6	4 300
	900	91 830	89.9	4 450	91 840	90.0	4 450

BUCKET SELECTION GUIDE

Bucket type		Capacity	Cutting width	Tip radius	Weight	Teeth	EC950E		
							7.25m boom		8.4m boom
							650mm shoe, 16 100kg counterweight		
		m ³	mm	mm	kg	EA	2.95m	2.95m	3.7m
Direct fit Buckets (V4) – Universal Cut	General purpose	3.9	1 970	2 221	4 187	5	C	C	C
		4.7	2 050	2 348	4 515	5	C	C	C
		5.4	2 350	2 400	4 669	5	C	C	B
	Heavy duty	3.9	1 970	2 275	5 066	5	D	D	D
		4.7	2 050	2 400	5 642	5	D	D	C
		5.2	2 200	2 400	5 907	5	D	C	B
		5.4	2 280	2 400	6 058	5	D	C	B
		5.6	2 350	2 400	6 167	5	D	B	B
Direct fit Buckets(V6)	Extreme Duty	5.6	2 500	2 700	6 886	5	D	B	A
Bucket type		Capacity	Cutting width	Tip radius	Weight	Teeth	EC950E		
							7.25m Boom		
							650mm shoe, 16 100kg counterweight		
		m ³	mm	mm	kg	EA	2.95m		
Direct fit Buckets (V4) – Universal Cut *India only	Heavy duty	3.9	1 970	2 275	5 066	5	D		
		4.7	2 050	2 400	5 642	5	D		
		5.2	2 200	2 400	5 907	5	D		
		5.4	2 280	2 400	6 058	5	D		
		5.6	2 350	2 400	6 167	5	D		

Please consult with your Volvo dealer for the proper match of buckets and attachments to suit the application.

The recommendations are given as a guide only, based on typical operation conditions.

Bucket capacity based on ISO 7451, heaped material with a 1:1 angle of repose.

Maximum material density

A	1 200~1 300 kg/m ³	Coal, Caliche, Shale
B	1 400~1 600 kg/m ³	Wet earth and clay, Limestone, Sandstone
C	1 700~1 800 kg/m ³	Granite, Wet sand, Well blasted rock
D	1 900 kg/m ³ ~	Wet mud, Iron ore

Specifications

DIMENSIONS

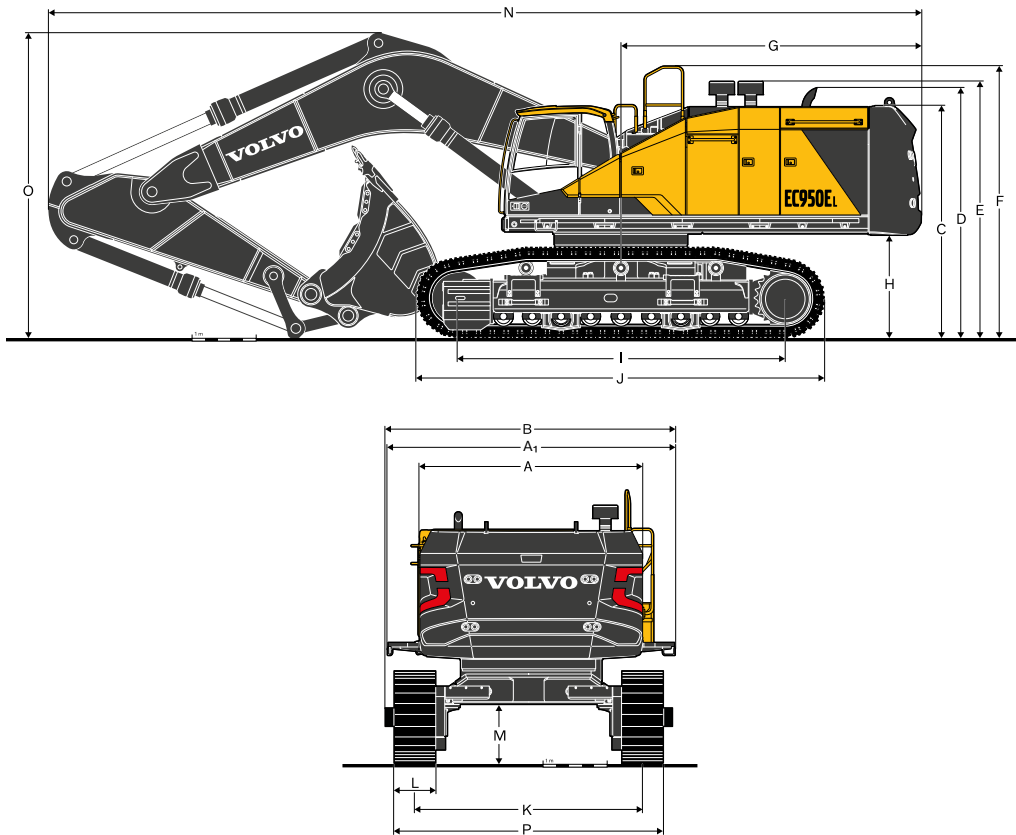

Description	Unit	EC950E		
		7.25	8.4	3.7
Boom	m			
Arm	m	2.95	2.95	3.7
A Overall width of superstructure	mm	3 485	3 485	3 485
A ₁ Overall width of superstructure (incl. walkway)	mm	4 505	4 505	4 505
B Overall width (step to walkway)				
650mm shoe	mm	4 515	4 515	4 515
750mm shoe	mm	4 515	4 515	4 515
900mm shoe	mm	4 520	4 520	4 520
C Overall height of cab	mm	3 655	3 655	3 655
D Overall height of tail pipe	mm	3 930	3 930	3 930
E Overall height of precleaner	mm	4 025	4 025	4 025
Overall height of oil bath	mm	4 180	4 180	4 180
F Overall height of guardrail	mm	4 265	4 265	4 265
G Tail swing radius	mm	4 700	4 700	4 700
H Counterweight clearance *	mm	1 620	1 620	1 620
I Tumbler length	mm	5 120	5 120	5 120
J Track length	mm	6 380	6 380	6 380
K Track gauge (extended)	mm	3 550	3 550	3 550
L Shoe width	mm	650	650	650
M Min. ground clearance *	mm	915	915	915
N Overall length	mm	13 615	14 765	14 600
O Overall height of boom	mm	4 950	4 875	4 905
P Width of Track (retracted)				
650mm shoe	mm	3 630	3 630	3 630
750mm shoe	mm	3 920	3 920	3 920
900mm shoe	mm	4 070	4 070	4 070
Width of Track (extended)				
650mm shoe	mm	4 200	4 200	4 200
750mm shoe	mm	4 300	4 300	4 300
900mm shoe	mm	4 450	4 450	4 450

* With shoe grouser

DIMENSIONS

Boom cylinder

Length	Height	Width	Weight
mm	mm	mm	kg
3 000	600	480	900 x 2 set = 1 800

Hose of Boom cylinder

Length	Weight	Q'ty
mm	kg	EA
1 250	5	2
1 170	4	2

Counterweight

Length	Height	Width	Weight
mm	mm	mm	kg
3 485	2 150	830	16 100

Shoes

Shoe width	Length	Height	Overall width	Weight / unit
mm	mm	mm	mm	kg
650	6 380	1 445	1 085	12 930
750	6 380	1 445	1 085	13 300
900	6 380	1 445	1 160	13 860

Superstructure

Length	Height of tail pipe	Width*	Weight
mm	mm	mm	kg
6 600	3 015	3 475	42 810

*Upper structure rotated by 90deg (across)

Basic machine (without counterweight)

Shoe width	Length	Height of tail pipe	Overall width (retracted)	Weight
mm	mm	mm	mm	kg
650	7 475	4 025	3 685	52 520
750	7 475	4 025	3 685	53 270
900	7 475	4 025	3 690	54 390

Walkway

Location	Length	Width	Height	Weight
LH front	1 310	480	65	21
LH rear	1 545	480	65	25
RH front	1 020	480	65	17
RH rear	1 115	480	65	18
Middle	1 210	480	65	21

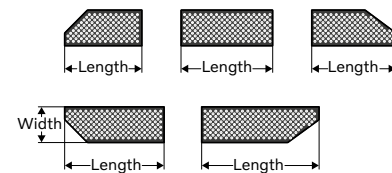
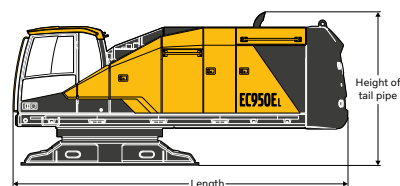
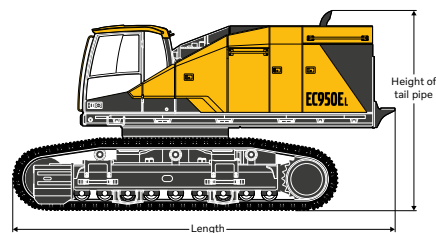
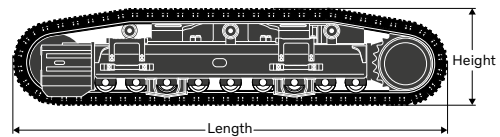
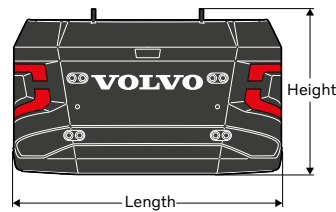
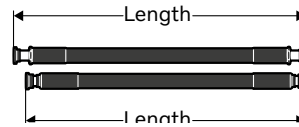
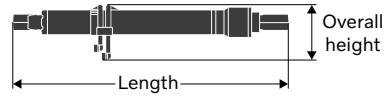

Specifications

DIMENSIONS

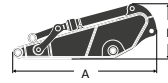
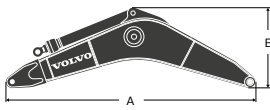

Description	Unit	EC950E		Description	Unit	EC950E	
		7.25	8.4			2.95	3.7
Boom	m			Arm	m		
Length (A)	mm	7 620	8 590	Length (A)	mm	4 470	5 210
Height (B)	mm	2 580	2 395	Height (B)	mm	1 675	1 485
Width	mm	1 100	1 100	Width	mm	835	790
Weight	kg	9 580	9 130	Weight	kg	5 470	5 340

* Includes cylinder, piping and pin

* Includes bucket cylinder, linkage and pin

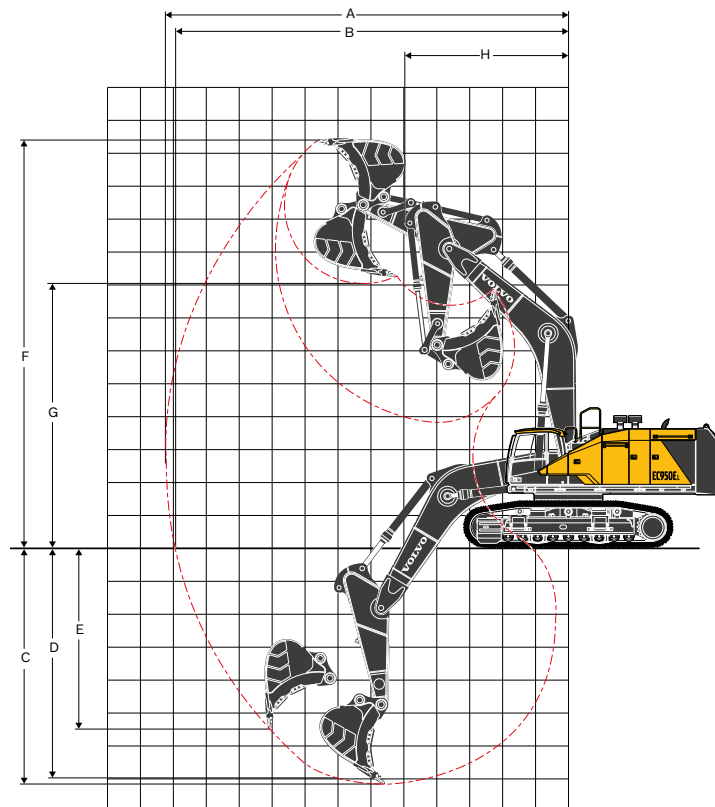

WORKING RANGES

Description	Unit	EC950E		
		7.25	8.4	3.7
Boom	m			
Arm	m			
A Max. digging reach	mm	12 270	13 480	14 020
B Max. digging reach on ground	mm	11 950	13 190	13 750
C Max. digging depth	mm	7 120	8 330	8 950
D Max. digging depth (I = 2.44 m level)	mm	6 980	8 180	8 820
E Max. vertical wall digging depth	mm	5 390	6 450	7 300
F Max. cutting height	mm	12 410	13 100	13 280
G Max. dumping height	mm	8 090	8 790	9 200
H Min. front swing radius	mm	4 970	6 010	5 910

DIGGING FORCES WITH DIRECT FIT BUCKET

Bucket radius		mm	2 348	2 348	2 221
Breakout force -bucket	SAE J1179	kN	424	424	341
	ISO 6015	kN	478	478	388
Tearout force -dipper arm	SAE J1179	kN	408	408	350
	ISO 6015	kN	420	420	359
Rotation angle, bucket		°	170	170	170

LIFTING CAPACITY EC950E

Lifting capacity at the arm end without bucket.

For lifting capacity including bucket, simply subtract actual weight of the direct fit bucket or the bucket with quick coupler from the following values.

	Lifting hook related to ground level	3.0 m		4.5 m		6.0 m		7.5 m		9.0 m		10.5 m		12.0 m		Max. reach			
		Along UC	Across UC	Along UC	Across UC	Along UC	Across UC	Along UC	Across UC	Along UC	Across UC	Along UC	Across UC	Along UC	Across UC	Along UC	Across UC	Max. m	
Boom: 7.25m	9.0 m	kg							*23 460	*23 460							*20 910	*20 910	7.7
Arm: 2.95m	7.5 m	kg							*23 510	*23 510							*20 070	*20 070	8.7
Shoe: 650mm	6.0 m	kg			*37 120	*37 120	*29 050	*29 050	*24 820	*24 820	*22 420	20 390					*19 950	19 010	9.4
CWT: 16 100kg	4.5 m	kg					*32 750	*32 750	*26 650	26 340	*23 150	19 890					*20 420	17 440	9.8
	3.0 m	kg					*35 920	35 180	*28 390	25 300	*23 940	19 330					*21 470	16 690	9.9
	1.5 m	kg					*37 460	33 930	*29 440	24 490	*24 360	18 870					*22 080	16 620	9.8
	0 m	kg			*36 090	*36 090	*37 110	33 370	*29 410	24 030	*23 940	18 610					*22 140	17 250	9.5
	-1.5 m	kg	*31 420	*31 420	*43 830	*43 830	*34 950	33 320	*27 890	23 930							*22 010	18 830	8.9
	-3.0 m	kg	*43 960	*43 960	*37 790	*37 790	*30 650	*30 650	*24 050	*24 050							*21 310	*21 310	8.1
	-4.5 m	kg			*28 250	*28 250	*22 610	*22 610									*18 990	*18 990	6.7
Boom: 8.4m	10.5 m	kg															*21 080	*21 080	8.0
Arm: 2.95m	9.0 m	kg							*21 140	*21 140	*19 870	*19 870					*19 830	*19 830	9.2
Shoe: 650mm	7.5 m	kg							*22 260	*22 260	*20 040	*20 040					*19 200	16 910	10.1
CWT: 16 100kg	6.0 m	kg					*29 620	*29 620	*24 060	*24 060	*20 870	19 930	*18 990	15 500			*18 880	15 120	10.6
	4.5 m	kg							*26 040	25 100	*21 920	19 200	*19 340	15 170			*18 730	14 070	11.0
	3.0 m	kg							*27 650	23 960	*22 850	18 520	*19 720	14 790			*18 680	13 550	11.1
	1.5 m	kg							*28 430	23 190	*23 360	17 990	*19 840	14 490			*18 670	13 470	11.1
	0 m	kg					*34 910	31 740	*28 230	22 800	*23 240	17 680	*19 370	14 340			*18 620	13 860	10.8
	-1.5 m	kg					*32 750	31 860	*26 980	22 740	*22 220	17 620					*18 430	14 830	10.3
	-3.0 m	kg			*33 770	*33 770	*29 450	*29 450	*24 500	22 980	*19 780	17 860					*17 900	16 700	9.5
	-4.5 m	kg			*27 830	*27 830	*24 410	*24 410	*20 020	*20 020							*16 570	*16 570	8.4
	-6.0 m	kg					*15 920	*15 920											6.8
Boom: 8.4m	10.5 m	kg															*14 650	*14 650	8.9
Arm: 3.7m	9.0 m	kg									*18 350	*18 350					*13 860	*13 860	10.0
Shoe: 650mm	7.5 m	kg									*18 870	*18 870	*17 600	16 110			*13 540	*13 540	10.8
CWT: 16 100kg	6.0 m	kg					*27 560	*27 560	*22 770	*22 770	*19 900	*19 900	*18 070	15 830			*13 540	*13 540	11.4
	4.5 m	kg					*31 600	*31 600	*24 960	*24 960	*21 140	19 570	*18 680	15 400			*13 830	12 920	11.7
	3.0 m	kg					*34 780	33 730	*26 910	24 490	*22 300	18 810	*19 300	14 960			*14 370	12 460	11.8
	1.5 m	kg					*36 180	32 440	*28 150	23 550	*23 110	18 190	*19 700	14 580			*15 290	12 370	11.7
	0 m	kg					*35 920	31 890	*28 470	22 980	*23 360	17 770	*19 660	14 320			*16 640	12 660	11.5
	-1.5 m	kg			*28 940	*28 940	*34 420	31 800	*27 780	22 760	*22 830	17 580	*18 870	14 240			*17 470	13 400	11.0
	-3.0 m	kg	*30 090	*30 090	*38 540	*38 540	*31 740	*31 740	*25 950	22 830	*21 230	17 650					*17 240	14 810	10.3
	-4.5 m	kg	*37 790	*37 790	*32 930	*32 930	*27 550	*27 550	*22 600	*22 600	*17 690	*17 690					*16 540	*16 540	9.3
	-6.0 m	kg			*24 690	*24 690	*20 940	*20 940	*16 240	*16 240							*14 670	*14 670	7.9

Notes: 1. Machine in "Fine Mode-F" (Power Boost) for lifting capacities.

2. The above loads are in compliance with SAE J1097 and ISO 10567 Hydraulic Excavator Lifting Capacity Standards.

3. Rated loads do not exceed 87% of hydraulic lifting capacity or 75% of tipping load.

4. Rated loads marked with an asterisk (*) are limited by hydraulic capacity rather than tipping load.

Specifications

LIFTING CAPACITY EC950E

Lifting capacity at the arm end without bucket.

For lifting capacity including bucket, simply subtract actual weight of the direct fit bucket or the bucket with quick coupler from the following values.

	Lifting hook related to ground level	3.0 m		4.5 m		6.0 m		7.5 m		9.0 m		10.5 m		12.0 m		Max. reach		
		Along UC	Across UC	Along UC	Across UC	Along UC	Across UC	Along UC	Across UC	Along UC	Across UC	Along UC	Across UC	Along UC	Across UC	Along UC	Across UC	Max. m
Boom: 7.25m	9.0 m kg							*23 460	*23 460							*20 910	*20 910	7.7
Arm: 2.95m	7.5 m kg							*23 510	*23 510							*20 070	*20 070	8.7
Shoe: 750mm	6.0 m kg			*37 120	*37 120	*29 050	*29 050	*24 820	*24 820	*22 420	20 540					*19 950	19 150	9.4
CWT: 16 100kg	4.5 m kg					*32 750	*32 750	*26 650	26 530	*23 150	20 040					*20 420	17 580	9.8
	3.0 m kg					*35 920	35 440	*28 390	25 490	*23 940	19 480					*21 470	16 830	9.9
	1.5 m kg					*37 460	34 190	*29 440	24 680	*24 360	19 020					*22 140	16 750	9.8
	0 m kg			*36 090	*36 090	*37 110	33 630	*29 410	24 220	*23 940	18 760					*22 140	17 390	9.5
	-1.5 m kg	*31 420	*31 420	*43 830	*43 830	*34 950	33 580	*27 890	24 120							*22 010	18 980	8.9
	-3.0 m kg	*43 960	*43 960	*37 790	*37 790	*30 650	*30 650	*24 050	*24 050							*21 310	*21 310	8.1
	-4.5 m kg			*28 250	*28 250	*22 610	*22 610									*18 990	*18 990	6.7
Boom: 8.4m	10.5 m kg															*21 080	*21 080	8.0
Arm: 2.95m	9.0 m kg							*21 140	*21 140	*19 870	*19 870					*19 830	*19 830	9.2
Shoe: 750mm	7.5 m kg							*22 260	*22 260	*20 040	*20 040					*19 200	17 050	10.1
CWT: 16 100kg	6.0 m kg					*29 620	*29 620	*24 060	*24 060	*20 870	20 090	*18 990	15 630			*18 880	15 250	10.6
	4.5 m kg							*26 040	25 300	*21 920	19 350	*19 340	15 290			*18 730	14 190	11.0
	3.0 m kg							*27 650	24 150	*22 850	18 670	*19 720	14 920			*18 680	13 660	11.1
	1.5 m kg							*28 430	23 380	*23 360	18 140	*19 840	14 610			*18 670	13 590	11.1
	0 m kg					*34 910	32 000	*28 230	22 990	*23 240	17 830	*19 370	14 460			*18 620	13 980	10.8
	-1.5 m kg					*32 750	32 130	*26 980	22 930	*22 220	17 770					*18 430	14 960	10.3
	-3.0 m kg			*33 770	*33 770	*29 450	*29 450	*24 500	23 170	*19 780	18 020					*17 900	16 840	9.5
	-4.5 m kg			*27 830	*27 830	*24 410	*24 410	*20 020	*20 020							*16 570	*16 570	8.4
	-6.0 m kg					*15 920	*15 920											6.8
Boom: 8.4m	10.5 m kg															*14 650	*14 650	8.9
Arm: 3.7m	9.0 m kg									*18 350	*18 350					*13 860	*13 860	10.0
Shoe: 750mm	7.5 m kg									*18 870	*18 870	*17 600	16 230			*13 540	*13 540	10.8
CWT: 16 100kg	6.0 m kg					*27 560	*27 560	*22 770	*22 770	*19 900	*19 900	*18 070	15 950			*13 540	*13 540	11.4
	4.5 m kg					*31 600	*31 600	*24 960	*24 960	*21 140	19 720	*18 680	15 530			*13 830	13 030	11.7
	3.0 m kg					*34 780	33 990	*26 910	24 680	*22 300	18 970	*19 300	15 080			*14 370	12 570	11.8
	1.5 m kg					*36 180	32 700	*28 150	23 740	*23 110	18 340	*19 700	14 700			*15 290	12 480	11.7
	0 m kg					*35 920	32 150	*28 470	23 170	*23 360	17 920	*19 660	14 440			*16 640	12 770	11.5
	-1.5 m kg			*28 940	*28 940	*34 420	32 060	*27 780	22 950	*22 830	17 740	*18 870	14 370			*17 470	13 520	11.0
	-3.0 m kg	*30 090	*30 090	*38 540	*38 540	*31 740	*31 740	*25 950	23 020	*21 230	17 800					*17 240	14 940	10.3
	-4.5 m kg	*37 790	*37 790	*32 930	*32 930	*27 550	*27 550	*22 600	*22 600	*17 690	*17 690					*16 540	*16 540	9.3
	-6.0 m kg			*24 690	*24 690	*20 940	*20 940	*16 240	*16 240							*14 670	*14 670	7.9

Notes: 1. Machine in "Fine Mode-F" (Power Boost) for lifting capacities.

2. The above loads are in compliance with SAE J1097 and ISO 10567 Hydraulic Excavator Lifting Capacity Standards.

3. Rated loads do not exceed 87% of hydraulic lifting capacity or 75% of tipping load.

4. Rated loads marked with an asterisk (*) are limited by hydraulic capacity rather than tipping load.

LIFTING CAPACITY EC950E

Lifting capacity at the arm end without bucket.

For lifting capacity including bucket, simply subtract actual weight of the direct fit bucket or the bucket with quick coupler from the following values.

	Lifting hook related to ground level	3.0 m		4.5 m		6.0 m		7.5 m		9.0 m		10.5 m		12.0 m		Max. reach					
		Along UC	Across UC	Along UC	Across UC	Along UC	Across UC	Along UC	Across UC	Along UC	Across UC	Along UC	Across UC	Along UC	Across UC	Along UC	Across UC	Max. m			
Boom: 7.25m	9.0 m	kg							*23 460	*23 460									*20 910	*20 910	7.7
Arm: 2.95m	7.5 m	kg							*23 510	*23 510									*20 070	*20 070	8.7
Shoe: 900mm	6.0 m	kg			*37 120	*37 120	*29 050	*29 050	*24 820	*24 820	*22 420	20 760							*19 950	19 370	9.4
CWT: 16 100kg	4.5 m	kg					*32 750	*32 750	*26 650	*26 650	*23 150	20 270							*20 420	17 780	9.8
	3.0 m	kg					*35 920	35 830	*28 390	25 780	*23 940	19 710							*21 470	17 030	9.9
	1.5 m	kg					*37 460	34 590	*29 440	24 970	*24 360	19 250							*22 080	16 960	9.8
	0 m	kg			*36 090	*36 090	*37 110	34 020	*29 410	24 510	*23 940	18 990							*22 140	17 600	9.5
	-1.5 m	kg	*31 420	*31 420	*43 830	*43 830	*34 950	33 970	*27 890	24 410									*22 010	19 210	8.9
	-3.0 m	kg	*43 960	*43 960	*37 790	*37 790	*30 650	*30 650	*24 050	*24 050									*21 310	*21 310	8.1
	-4.5 m	kg			*28 250	*28 250	*22 610	*22 610											*18 990	*18 990	6.7
Boom: 8.4m	10.5 m	kg																	*21 080	*21 080	8.0
Arm: 2.95m	9.0 m	kg							*21 140	*21 140	*19 870	*19 870							*19 830	*19 830	9.2
Shoe: 900mm	7.5 m	kg							*22 260	*22 260	*20 040	*20 040							*19 200	17 240	10.1
CWT: 16 100kg	6.0 m	kg					*29 620	*29 620	*24 060	*24 060	*20 870	20 310	*18 990	15 820					*18 880	15 430	10.6
	4.5 m	kg							*26 040	25 580	*21 920	19 580	*19 340	15 480					*18 730	14 370	11.0
	3.0 m	kg							*27 650	24 440	*22 850	18 890	*19 720	15 100					*18 680	13 840	11.1
	1.5 m	kg							*28 430	23 670	*23 360	18 370	*19 840	14 800					*18 670	13 770	11.1
	0 m	kg					*34 910	32 400	*28 230	23 280	*23 240	18 060	*19 370	14 650					*18 620	14 160	10.8
	-1.5 m	kg					*32 750	32 520	*26 980	23 220	*22 220	18 000							*18 430	15 150	10.3
	-3.0 m	kg			*33 770	*33 770	*29 450	*29 450	*24 500	23 460	*19 780	18 240							*17 900	17 050	9.5
	-4.5 m	kg			*27 830	*27 830	*24 410	*24 410	*20 020	*20 020									*16 570	*16 570	8.4
	-6.0 m	kg					*15 920	*15 920													6.8
Boom: 8.4m	10.5 m	kg																	*14 650	*14 650	8.9
Arm: 3.7m	9.0 m	kg									*18 350	*18 350							*13 860	*13 860	10.0
Shoe: 900mm	7.5 m	kg									*18 870	*18 870	*17 600	16 420					*13 540	*13 540	10.8
CWT: 16 100kg	6.0 m	kg					*27 560	*27 560	*22 770	*22 770	*19 900	*19 900	*18 070	16 140					*13 540	*13 540	11.4
	4.5 m	kg					*31 600	*31 600	*24 960	*24 960	*21 140	19 950	*18 680	15 720					*13 830	13 190	11.7
	3.0 m	kg					*34 780	34 390	*26 910	24 970	*22 300	19 190	*19 300	15 270					*14 370	12 730	11.8
	1.5 m	kg					*36 180	33 090	*28 150	24 030	*23 110	18 570	*19 700	14 890					*15 290	12 640	11.7
	0 m	kg					*35 920	32 550	*28 470	23 460	*23 360	18 150	*19 660	14 630					*16 640	12 940	11.5
	-1.5 m	kg			*28 940	*28 940	*34 420	32 460	*27 780	23 240	*22 830	17 960	*18 870	14 550					*17 470	13 700	11.0
	-3.0 m	kg	*30 090	*30 090	*38 540	*38 540	*31 740	*31 740	*25 950	23 310	*21 230	18 030							*17 240	15 130	10.3
	-4.5 m	kg	*37 790	*37 790	*32 930	*32 930	*27 550	*27 550	*22 600	*22 600	*17 690	*17 690							*16 540	*16 540	9.3
	-6.0 m	kg			*24 690	*24 690	*20 940	*20 940	*16 240	*16 240									*14 670	*14 670	7.9

Notes: 1. Machine in "Fine Mode-F" (Power Boost) for lifting capacities.

2. The above loads are in compliance with SAE J1097 and ISO 10567 Hydraulic Excavator Lifting Capacity Standards.

3. Rated loads do not exceed 87% of hydraulic lifting capacity or 75% of tipping load.

4. Rated loads marked with an asterisk (*) are limited by hydraulic capacity rather than tipping load.

Equipment

STANDARD EQUIPMENT

Engine

Turbocharged, 4 stroke diesel engine with water cooling, direct injection and charged air cooler

Air filter with indicator

Air intake heater

Cyclone pre-cleaner

Electric engine shut-off

Fuel filter and water separator

Alternator, 80 A

Fuel filler pump, 100 l/min with automatic shut-off

Electric/Electronic control system

Contronics

Advanced mode control system

Self-diagnostic system

Machine status indication

Engine speed sensing power control

Emergency engine stop switch

Automatic idling system

Short cut switch

Safety stop/start function

Adjustable 8inch LCD color monitor

Master electrical disconnect switch

Engine restart prevention circuit

High-capacity halogen lights:

Cab-mounted 2

Frame-mounted 2

Boom-mounted 4

Batteries, 2 x 12 V / 210 Ah

Start motor, 28 V / 6.6 kW

Hydraulic system

Automatic sensing hydraulic system

Summation system

Boom priority

Arm priority

Swing priority

ECO mode fuel saving technology

Boom and arm regeneration valves

Swing anti-rebound valves

Boom and arm holding valves

Multi-stage filtering system

Cylinder cushioning

Cylinder contamination seals

Auxiliary hydraulic valve

Automatic two-speed travel motors

Hydraulic oil, ISO VG 46

Frame

Access way with handrail

Full height counterweight 16 100kg

Tool storage area

Side walk-way

Under cover (heavy duty 4.5mm)

Punched metal anti-slip plates

Cab and interior

Silicon oil and rubber mounts with spring

Adjustable operator seat with heater and joystick control console

Control joysticks with semi-long

Heater & air-conditioner, automatic

Flexible antenna

Radio with CD player & MP3 player and USB

Hydraulic safety lock lever

Cab, all-weather sound suppressed, includes:

Cup holders

Door locks

Tinted glass

Floor mat

Horn

Large storage area

Pull-up type front window

Removable lower windshield

Seat belt

Safety glass

Sun screens, front, roof, rear

Windshield wiper with intermittent feature

Master key

Undercarriage

Mechanically retractable track gauge

Hydraulic track adjusters

Greased and sealed track link

Track Guard

Under cover (10mm)

Track shoes

Track shoes, 650 mm with double grouser

Digging equipment

Boom: ME 7.25 m

Arm: ME 2.95 m

Manual centralized lubrication

OPTIONAL EQUIPMENT

Engine

Block heater: 240 V

Dual stage oil bath pre-cleaner

Diesel coolant heater, 10 kW

Water separator with heater

Extra water separator

Auto engine shutdown

Electric

Extra lights :

Cab-mounted 3 (front 2, rear 1)

Boom-mounted 4

Frame-mounted 2

Counterweight-mounted 1

Travel alarm

Anti-theft system

Rotating warning beacon

OPTIONAL EQUIPMENT

Hydraulic system

- Hose rupture valve: boom, arm
- Straight travel pedal
- Bucket conflux
- Boom float function with HRV
- Boom float function without HRV
- Hydraulic piping:
 - Work tool management system (up to 20 programmable memories)
 - Hammer & shear, 1 and 2 pump flow
 - Hammer & shear: variable flow and pressure pre-setting
 - Additional return filter
- Grapple
 - Quick coupler piping
- Hydraulic oil, ISO VG 32, 68
- Hydraulic oil, biodegradable 46
- Hydraulic oil, longlife oil 32, 46, 68

Cab and interior

- One-piece fixed front windshield
- Fabric seat without heater
- Fabric seat with heater and air suspension
- Control joysticks with 4 switches each
- Control joysticks with 3 switch & 1 proportional
- Opening top hatch
- Front rain shield
- Falling object guard (FOG)
 - Frame-mounted
 - Cab-mounted

Cab and interior

- Cab-mounted falling object protective structure (FOPS)
- Smoker kit (ashtray and lighter)
- Safety net for front window
- Sunlight protection, roof (steel)
- Lower wiper with intermittent control
- Cleaning air gun
- Rear view camera
- Side view camera
- Specific key

Undercarriage

- Full track guard

Track shoes

- 750/900mm track shoes with double grousers

Digging equipment

- Boom: 8.4m
- Arm: 3.7m

Service

- Tool kit, daily maintenance
- Tool kit, full scale
- Special tool for retractable frame
- Automatic lubrication system

Others

- Siberian option package
- Auto fire suppression system

SELECTION OF VOLVO OPTIONAL EQUIPMENT

Auto lubrication system**1-piece window****Rear and side view camera****Reversible fan****Oil bath pre cleaner****Auto fire suppression**

Not all products are available in all markets. Under our policy of continuous improvement, we reserve the right to change specifications and design without prior notice. The illustrations do not necessarily show the standard version of the machine.



VOLVO

Volvo Construction Equipment

volvoce.com